

2 WIRE VIDEO SYSTEM

DT471-TD7

7" VIDEO HANDS-FREE COLOR TFT MONITOR

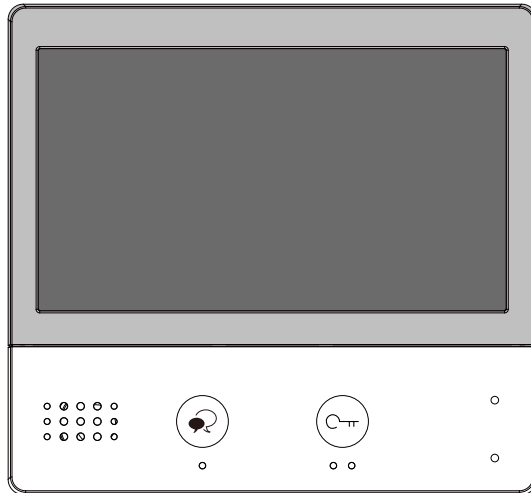

- Please read this manual carefully before using the product you purchase, and keep it well for future use.
- Please note that images and sketch maps in this manual may be different from the actual product.

PRECAUTIONS

- Slots or openings in the back of the monitor, are provided for ventilation and to ensure reliable operation of the video monitor or equipment and to protect it from overheating. These openings must not be blocked or covered. The monitor should never be placed near or over a radiator or heat register and should not be placed in a built-in installation such as a bookcase unless proper ventilation is provided.
- All parts should be protected from violence vibration. And not allow be impacting, knocking and dropping.
- For clean the LCD screen, using hands or wet cloth is forbidden.
- Please do the cleanness with soft cotton cloth, please do not use the organic or chemical detergent. If necessary, please use pure water or dilute soap water to clean the dust.
- Image distortion may occur if the video door phone is mounted too close to magnetic field e. g. Microwaves, TV, computer etc.
- Please keep away the video door monitor from wet, high temperature, dust, and caustic and oxidation gas in order to avoid any unpredictable damage.
- Do not open the device in any condition, call the administrator for help if there is any problem.

CONTENTS

Front panel	1
Mounting	2
Screen	3
Answering a call	4
Pan-tilt & Zoom	5
Adjusting screen&volume	6
Door release	7
Calling other monitors	7
Monitoring	8
Recording	9
Viewing images/videos	10
Don't disturb function	10
Divert call	11
How to get QR code	11
Download Setup 2Easy APP	12
Surveillance door station via 2Easy APP	14
Opening staircase light	15
Setting rong tone	15
Setting ring volume	16
Setting monitor time	16
Enabling/Disabling intercom function	17
Delete all images/video	17
Restoring to default setting	18
Entering installer setup	18
Specification	22

Front panel

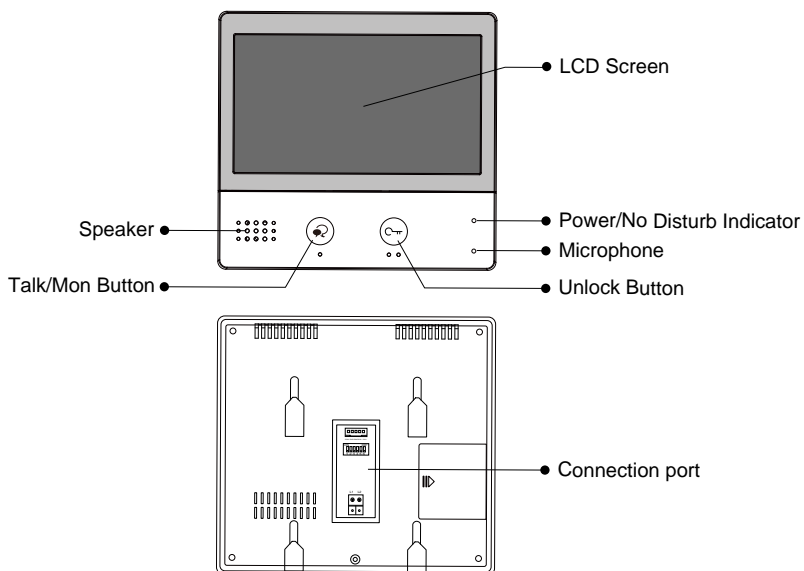

Key functions

Speaker	<ul style="list-style-type: none"> Send out voice from the visitor.
Talk/Mon button	<ul style="list-style-type: none"> Press to communicate hands free with visitor; Press to view the outdoor condition in standby mode.
LCD screen	<ul style="list-style-type: none"> Display the visitors' image.
Power/No Disturb indicator	<ul style="list-style-type: none"> Show the power status of the system. Show the no disturb status.
Microphone	<ul style="list-style-type: none"> Transmit audio from one station to other stations.
Unlock button	<ul style="list-style-type: none"> Press to release the door.
Connection port	<ul style="list-style-type: none"> Bus terminal, Setting the monitor's address.

Mounting

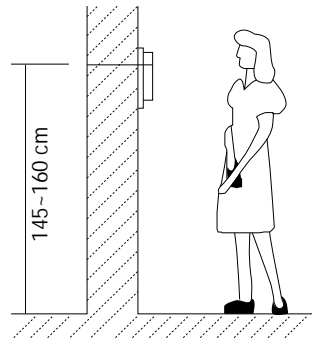
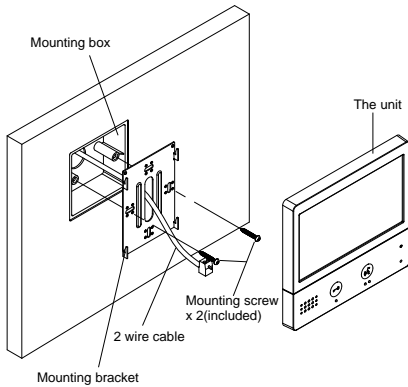

The installation height is suggested to 145~160cm.

1. Use screws to fasten the mounting bracket to the wall with mounting box.
2. Connect the 2 wire cables to the unit.
3. Mount the unit to the mounting bracket, make sure the unit is absolutely attached to the mounting bracket.

Terminal description

SW+,SW-: Extra door bell call button connection port.

Ring,GND: Extra buzzer connection port.

POW,GND: 12~16V extra power connection port.

DIP switches: Total 6 bits can be configured.

- **Bit1~Bit5**: User Code setting switch.
- **Bit6**: Video impedance matching switch.

L1,L2: Bus line terminal.

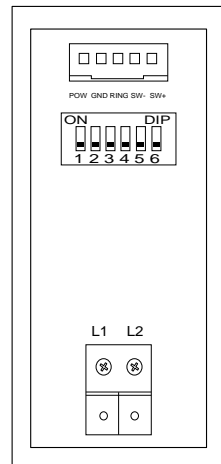

Screen

Main Menu

The Main menu is your starting point for using all the applications on your monitor.

Touch anywhere of the screen on monitor in standby mode, the Main menu will appear as follow:

Monitor

Touch it to view outdoor condition.

Touch this icon to directly enable/disable the don't disturb and divert function.

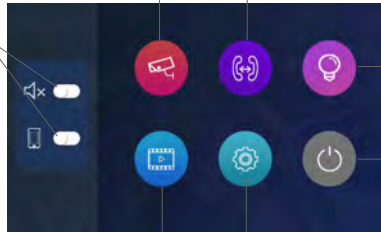

Intercom

Touch it to enter intercom selections.

Light

Touch it to light up the staircase light via RLC.

Close

Touch it to turn off the screen and make the monitor in standby mode.

Playback

Touch it to play recorded images or videos from door stations.

Setting

Press it to enter setup interface.

While talking with a door station

Displays which door station is calling.

Displays talking time.



Shows status of talking,unlocking ect.

This function needs the fisheye camera support.

Answering a call

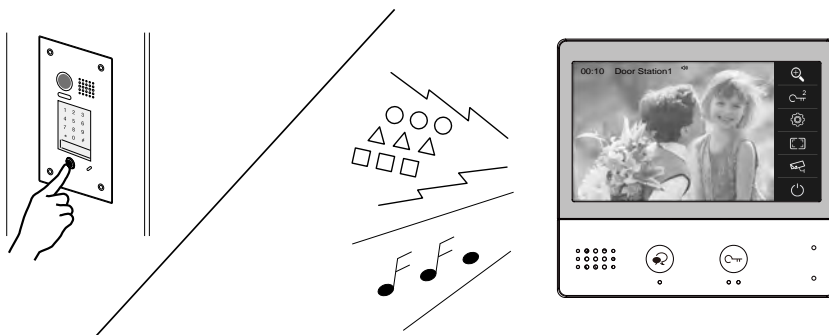

- When there is a call from a video door station. The call tone sounds, an image will be displayed on the screen.
- Press **TALK/MON** button on the panel, begin communicating hands free with the visitor for 90 seconds.
- While communicating with the visitor, unlock the door, capture images/videos and adjust screen&volume are available. More details, please refer to the following descriptions.

Note: If nobody answers the phone, the screen will be turned off automatically after 40 seconds.

Monitoring cameras while being called/talking

It's available to select cameras to monitor while being called.

Follow the steps:



Notes: Press **⏮** icon to cycle switch the camera if the system installs multi door stations/cameras.

Adjusting image scale while being called/talking

It's available to adjust image scale while being called. Total 2 image modes can be selected.

Follow the steps:

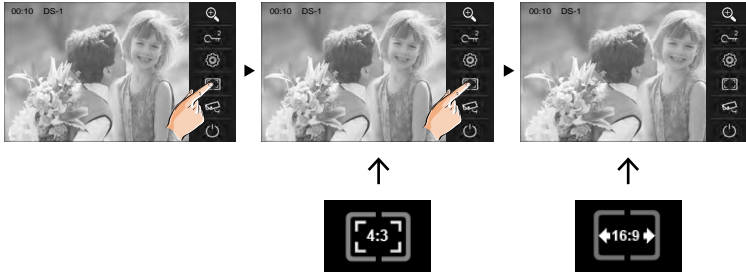

To complete communication

- Touch  icon on screen or press the  **TALK/MON** button on the panel to complete the communication.

Note: Communication also ends automatically after 90 seconds.

1.Receiving a call while talking with a door station

- Other door stations calling is forbidden
- Conclude current talking to answer the new call-in

2.Receiving a call while talking with other monitors

- The talking will stop immediately, call tone sounds in normal.
- The video image from the door station is displayed on the screen, talking,unlock,capture images/videos, adjust screen&volume are available.

Panview & Zoom

It is available to adjust the display mode for viewing images at a **fish-eye** door station.

When an image at a door station is displayed, touching  on the screen to view the image in zoom mode.

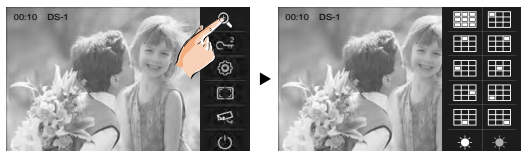

Note:

- 1.The zoom&pantilt function should make effective with fish-eye door station.
- 2.The edge of pantilt image will not be displayed.

Adjusting screen&volume

While receiving a call from door station, or monitoring /communicating with the visitor,you can adjust the screen and speaker volume. Follow the steps:

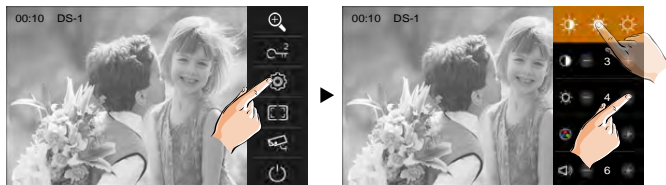



Adjusting images

Total 3 scene modes can be selected in sequence:**Normal**, **Brightly** and **Soft**.Whichever mode you choose, there will be a corresponding value for contrast,brightness and color.

You should know that the contrast,brightness and color can be modified freely.

 Adjust the contrast of the screen,the range is 0~9. Touch - or + to change the level.

 Adjust the brightness of the screen ,the range is 0~9. Touch - or + to change the level.

 Adjust the color of the screen,the range is 0~9. Touch - or + to change the level.

Note: The adjustments have no effect on the recorded images.

Adjusting the speaker volume

Volume can be adjusted at any time.

Adjusting range: 0 - 9.

 Touch - or + to reach desired level.

Door release

It is available to release the door during a call-in, communication, or while monitoring a door station.

Press **C-UNLOCK** button on panel to release door. The door lock is released for the set door release time.

(if two locks are connected to door station, touch **C-2** icon to release the second lock.)

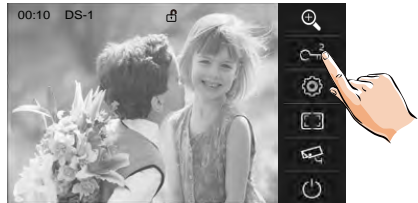

Calling other monitors

It is available to call between monitors in the same room or in the same system, or call the Guard Monitor. Follow the steps to activate the functions:

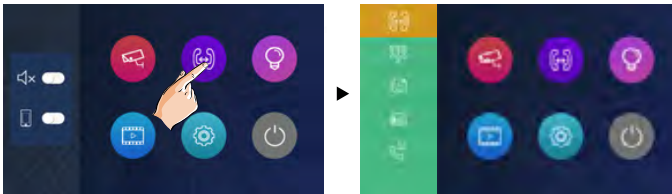

Calling monitors you want

Touch **CALL OTHER MONITORS** icon, then input the room code to call the monitor you want.

Calling monitors in the same room

Touch **CALL OTHER MONITORS** icon on one of monitor, all other monitors in the same room will ring at the same time, whichever monitor answers the call, conversation is started, other monitors will stop ringing at once.

Note: 1. the DIP switches setting of all monitors must be same.

2. Calling ends automatically after 30 seconds if nobody answers the call.

Calling other monitors in the same system

Touch  icon on monitor, the users in the same system will be displayed. Just select one target to call the corresponding user. If the call is answered, conversation is activated.

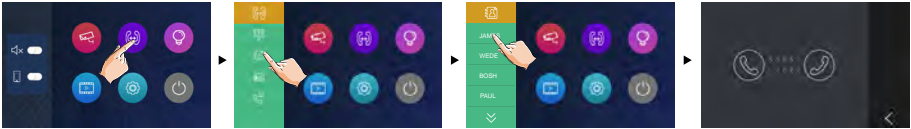

Note:

* Use "  " to scroll pages.

* Calling ends automatically after 30 seconds if nobody answers the call.

Calling the guard monitor

A Monitor can be assigned as Guard Unit Monitor; Touch  icon to activate the communication with guard station when the Guard Unit Monitor answers the call, conversation with the guard person is started.

Monitoring

You can monitor the entrance at any time via the monitor.

1.Touch anywhere of the screen on monitor in standby mode.

2.Touch  icon on main menu page to enter **Monitor select** page.

*Note: Press  **TALK/MON** button on panel in standby mode to monitor the master door station in shortcut.

Monitoring door stations/cameras:

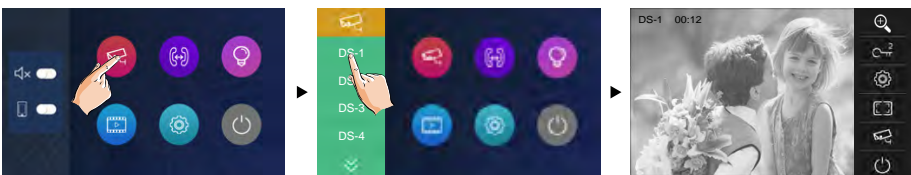

- It can be selected to monitor individually if the system installs multi door stations/cameras. See the following steps:



* During monitoring, images can be viewed, but audio cannot be heard.

* If there is a visitor at the entrance, press the  **TALK/MON** button on the panel to begin communication with door station.

3.To end monitoring

Touch  icon on the screen or press  **TALK/MON** button on panel.

* Monitoring also ends automatically after 30 seconds.

Available functions during monitoring(not including video quad monitoring)

- Pantilt & zoom
- Adjusting images(image scale/bright/color/contrast)
- Door release
- Volume control

Recording

This function needs the IPG support.

Videos and images are possible to be recorded by automatic recording.

Automatic recording

- Recording starts after 3 seconds while receiving a call.
- Capture one picture automatically for each calling.



The recorded images are stored in the built-in memory first.

- * Max.200 pictures can be stored in inner memory
- * If a micro-SD card is installed, images can be copied to SD card.
- * Max. 32G Micro SD card is supported.

Note:

- * Automatic recording function can be forbidden.
- * Automatic recording is not available while monitoring a door station.

Viewing images/videos

The recorded images/videos can be playback on monitor. Follow the steps:

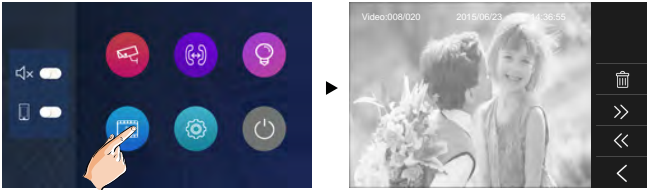

- Touch "<<" or ">>" to scroll through recordings, touch "🗑️" to delete current image/video (Please note that if the recordings are videos, touch "⏸️" icon to start/pause the videos).

Don't disturb function

If you don't want to be disturbed, for example, at night. Activating the don't disturb function is necessary for you. Follow the steps:

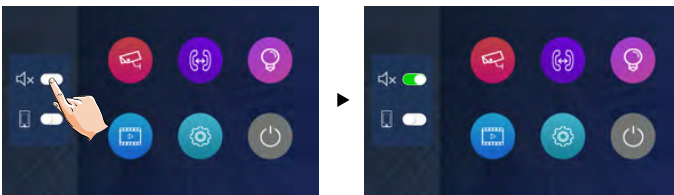

Do Not Disturb: If you select this mode, calling from door station or other monitors can not be made effect.

Divert call

The calling from door station can be diverted to your phone. please note that this function should be supported by the unit of IPG. Follow the steps to activate this function:

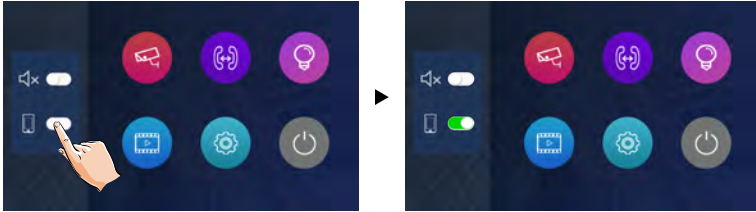

Two modes can be selected.

1. When both the divert function and the don't disturb function are activated, the divert mode is ***Divert, immediately.***

When receives call from door station, diverts the call to the phone immediately.

At this mode, the monitor will always close the screen and show image from door station during diverted, if the monitor answers the call at this time, diverted will conclude at once.

2. When the divert function is activated and the don't disturb function is turned off, the divert mode is ***Divert, If No Answer.***

If nobody answers the call in 30s when receives call from door station, diverts the call to the phone.

At this mode, the monitor will shut off the screen after diverting successfully, but you can still use it in normal.

Note:

* The time limited with the phone is 90s.

How to get QR code

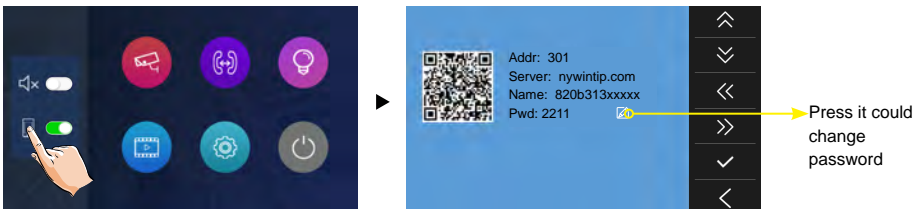

Download Setup 2Easy APP

1. Scan and download 2Easy APP, or search “2Easy” on APP store.

IOS



Android



2. Permit “2Easy” with internet access and camera, on monitor, in QR code page , and keep in QR code page. on 2Easy APP, press on top-right, to scan QR code on monitor, and press “Save”.

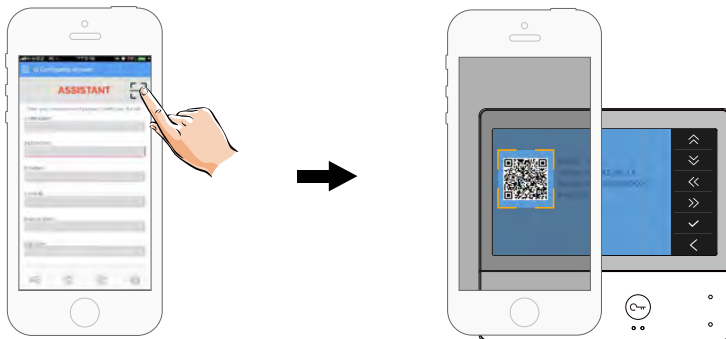

3. Disable "IPV6" on 2Easy APP

Most of internet provide doesn't support IPV6 feature, please manually disable it with follow steps:

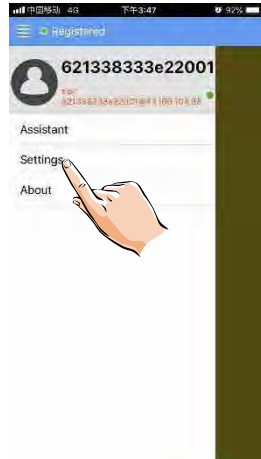

Press here to disable

4. After login SIP account on 2Easy APP, check on status bar, or press on the “Registered” area to manually register, until 2Easy APP display:

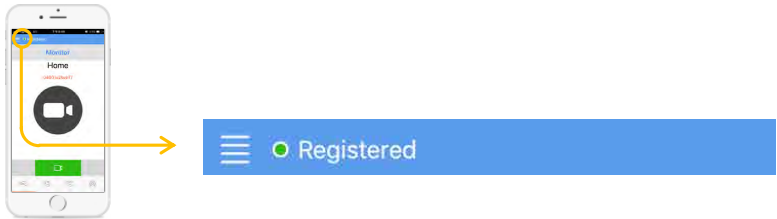

Surveillance door station via 2Easy APP

- On 2Easy APP, press on “Monitor” and wait for a few second (Due to 2-Wire communication will take around 12 second to get video), blue screen is normally due to the monitor is verifying the password and monitor code.



Opening staircase light

Note: The staircase light should be connected on the system, and this function should be supported by RLC. Please refer to RLC user instruction in detail.

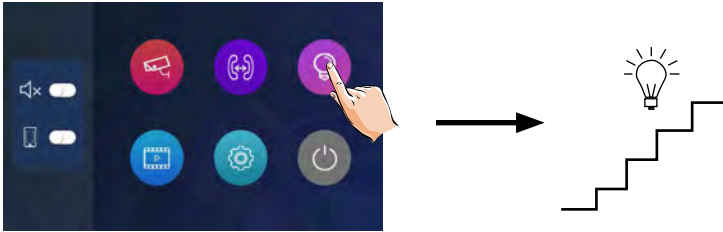

Touch  icon on main menu page to open the staircase light, the staircase light will be turned off automatically after 60 seconds.





*Touch  icon again to turn off the light.

Setting ring tone

The ring call tone can be set individually to distinguish different calling sources. Total 12 tones can be selected.

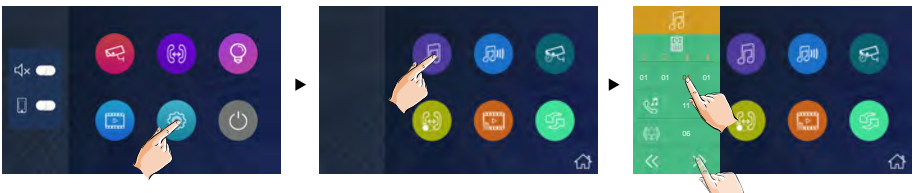



1. On main menu page, touch  icon -> touch  icon.
2. Touch the setting target of door tone, intercom tone, alert tone individually, then touch << / >> icon to change the tone. Settings will perform immediately.



- Note:**
1. Touch  icon, the door ring mode is selected to United, the ring tone of Door1/2/3/4 must be the same.
 2. Touch  icon to exit and return to main menu page.

Setting ring volume

The ring volume can be set individually. The setting range is 0~9.

- 1.On main menu page, touch  icon -> touch  icon.
- 2.Touch  /  icon to adjust the levels. Settings will perform immediately.

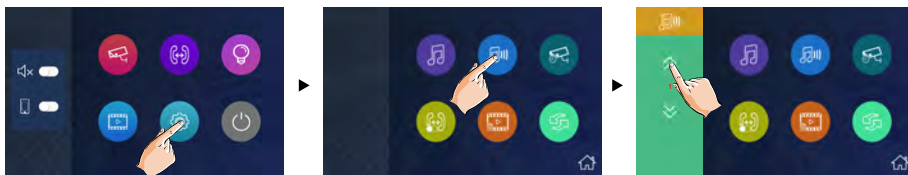





Note: 1.If the level is 0, it means that mute states (when receive the call from door station).

- 2.Touch  icon to exit and return to main menu page.

Setting monitor time

The monitor time can be changed. It's available to set 6s,10s,20s,30s,40s,50s,1min,2min,3min,4min,5min,6min,7min,8min,9min,10min.

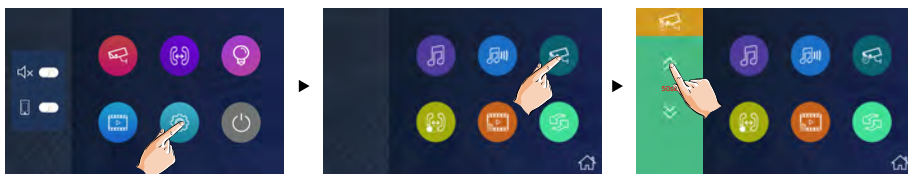

* 30s is the default monitor time.

- 1.On main menu page, touch  icon -> touch  icon.
- 2.Touch  /  icon to adjust the levels. Settings will perform immediately.



Enabling/Disabling intercom function

You can enable or disable intercom function from this monitor.

On main menu page, touch  icon -> touch  icon.

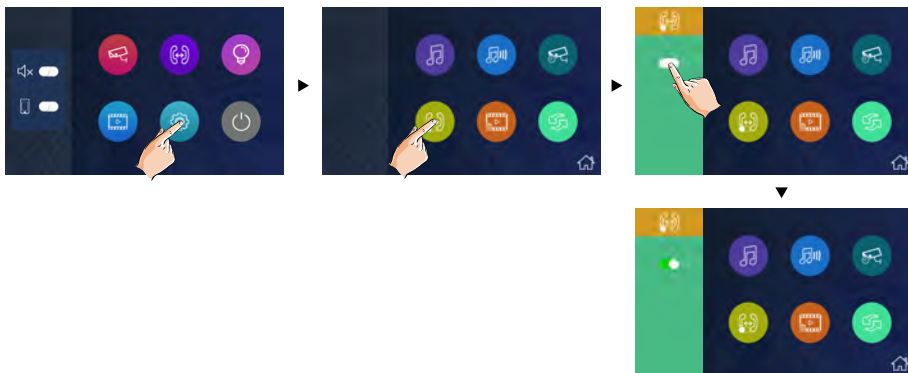



Note: *In default setting, intercom function is enable for the monitor.

*  means that the intercom function is forbidden.

*  means that the intercom function is Enabling.

Delete all images/video

You can delete all images/video from this monitor.

1. On main menu page, touch  icon -> touch  icon.



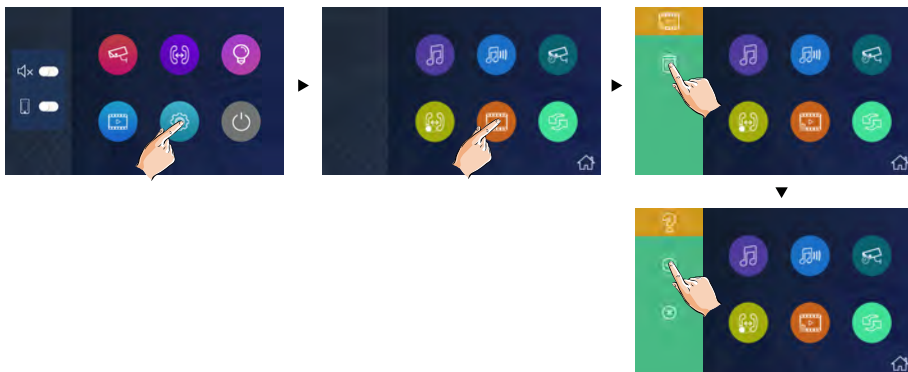

2. Touch  icon, a message will be asked.

3. Touch icon to start the restore. Touch icon to cancel.



Restoring to default setting

The restore to default function allows the user to recover the settings to factory setting.

1. On main menu page, touch  icon -> touch  icon.
2. Touch  icon, a message will be asked.
3. Touch  icon to start the restore. Touch  icon to cancel.

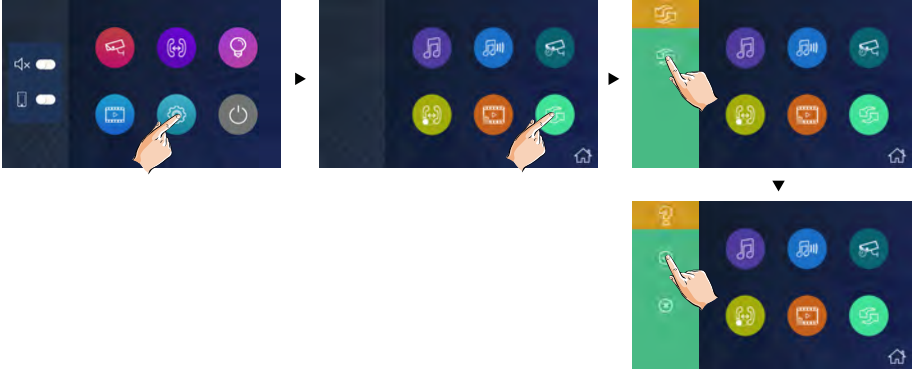

* If restoring to default is completed, a sound beep will be sent out.

Entering installer setup

- On main menu page, touch  icon.
- When the screen stay in **About** page, press **C⇐** **UNLOCK** button on front panel and hold for 3 seconds.
- A keypad is shown.

Refer to the followings:



The setting code and items

Code	Setting Item	Code	Setting Item
2419	Restore To Default	8016-8017	Bypass Enable/Disable
2500-2549	RM Parameter Set	8018-8020	Video Format
8000-8003	Setting master/slave monitor	8401-8499	Unlock Time
8004-8005	Guard Unit Enable	8505-8520	Divert Time
8006-8007	Panel On/Off	9017-9018	Memory On/Off
8008-8009	Date Mode	9030-9031	Doc. Function On/Off
8010-8011	Unlock Mode:Close/Open	9101-9104	Door Station Quantity
8012-8013	Time Mode:12 hour/24 hour	9200-9216	Camera Quantity

Setting as a Guard Monitor

A Monitor can be assigned as **Guard Unit Monitor**; when the Guard Unit Monitor answers the call, conversation with the guard person is started..

- The code of 8004 is used to set the monitor as a guard unit monitor.
- The code of 8005 is used to cancel this function.

Setting date and time format

The system offers two ways of date and time.

- The code of 8008 is used to set the date format as month/date/year.
- The code of 8009 is used to set the date format as date/month/year.
- The code of 8012 is used to set the time format as 12 hour system.
- The code of 8013 is used to set the time format as 24 hour system.

Setting unlock parameter

Unlock mode:

There are two unlock modes: 1.power-on- to-unlock type:unlock mode=0(by default)
2.power-off-to-unlock:unlock mode=1.

- The code of 8010 is used to set the unlock mode to 0
- The code of 8011 is used to set the unlock mode to 1

Unlock time:

- The unlock time can be changed by yourself at any time. it can be set from 1 to 99 seconds.
- The code from 8401 to 8499 are used to set the unlock time to 1~ 99 seconds.

Setting user code

On DT system, every apartment must assign a unique identification called **User Code**.

DIP Switcher Set Address

The DIP switches are used to set the user code for each monitor.Total 6 bits can be configured.

- Bit-1 to Bit-5 are used for user code setting. The value range is from 0 to 31, which have 32 different codes for 32 apartments.

- When multi monitors need to be installed in one apartment, these monitors should use the same user code, and the master/slave mode should be set on the monitor. (Details refer to the section of **Setting Slave Monitor**)
- Bit-6 is bus line terminal switch, which should be set to “ON” if the monitor is at the end of bus line, otherwise be set to “OFF”.

Bit-6 switch setting



Bit state	Setting	Bit state	Setting
	When monitor is not at the end of bus line.		When monitor is at the end of bus line.

Bit state	User Code	Bit state	User Code	Bit state	User Code
	Code=1		Code=12		Code=23
	Code=2		Code=13		Code=24
	Code=3		Code=14		Code=25
	Code=4		Code=15		Code=26
	Code=5		Code=16		Code=27
	Code=6		Code=17		Code=28
	Code=7		Code=18		Code=29
	Code=8		Code=19		Code=30
	Code=9		Code=20		Code=31
	Code=10		Code=21		Code=32
	Code=11		Code=22		

Specification

Power supply:	DC 20~28V
Power consumption:	Standby 0.25W; Working 5W
Communication:	Hands-free
Screen:	7 Inch digital color TFT
Display Resolutions:	800*3(R, G, B) x 480 pixels
Video signal:	1Vp-p, 75Ω, CCIR standard
Wiring:	2 wires, non-polarity
Dimension:	161(H)×174(W)×22(D)mm

FOR TECHNICAL SUPPORT CALL
1516-387-6606 FROM 9AM TILL 4PM
MONDAY THRU FRIDAY
OUR WEBSITE WWW.NYWINT.COM

DT-ENG-471-TD7-V1

The design and specifications can be changed without notice to the user. Right to interpret and copyright of this manual are preserved.