

# 2 WIRE SYSTEM

## DT-AKP

Access keypad panel with scramble keypad

### User Manual

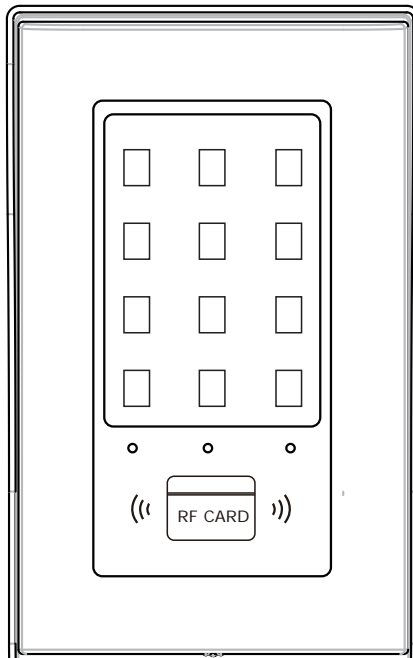

- Please read this manual carefully to ensure safe and correct operation.
- Keep this manual well for future reference.

# Contents

<b>1.Parts and Functions</b> .....	1
<b>2.Terminal Descriptions</b> .....	1
<b>3.Mounting</b> .....	2
<b>4.Electric Lock Connection</b> .....	2
4.1 Internal Power Supply Mode .....	2
4.2 External Power Supply Mode .....	3
<b>5.Functions Setup</b> .....	4
5.1 Setting Items and Codes .....	4
5.2 LED Indicator Definitions .....	6
5.3 Digitron Display Prompt.....	6
5.4 Setting Steps .....	8
<b>6.System Wiring and Connections</b> .....	14
<b>7.Unlock Operations</b> .....	15
<b>8.Specifications</b> .....	15
<b>9.Precautions</b> .....	16

# 1.Parts and Functions

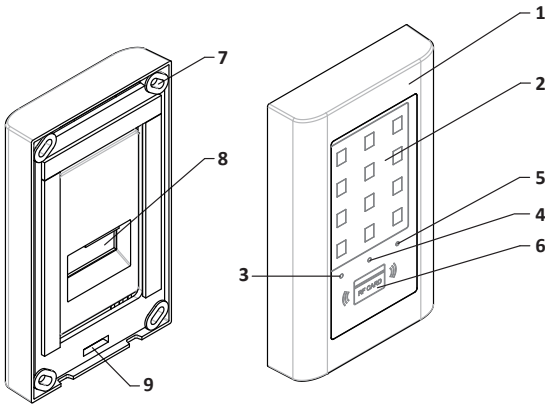

- [1] Front panel
- [2] Touch sensitive digital keypad
- [3] LED1 indicator
- [4] LED2 indicator
- [5] LED3 indicator
- [6] ID card window
- [7] Mounting hook
- [8] Connection port
- [9] Screw hole

# 2.Terminal Descriptions

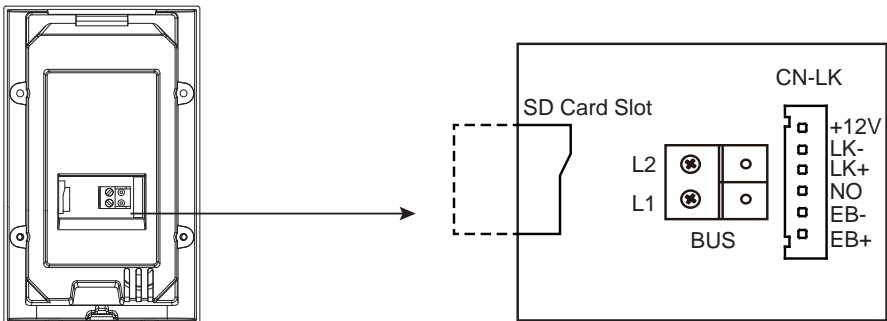

- **SD Card Slot:** To insert micro SD card.
- **BUS:** Connect to the bus line, non polarity.
- **+12V:** 12VDC power output.
- **LK+:** Common contact of the relay.
- **LK-:** Power ground.
- **NO:** Normally open contact of the relay.
- **EB+:** Exit button power(+) output.
- **EB-:** Exit button power(-) output.

## 3. Mounting

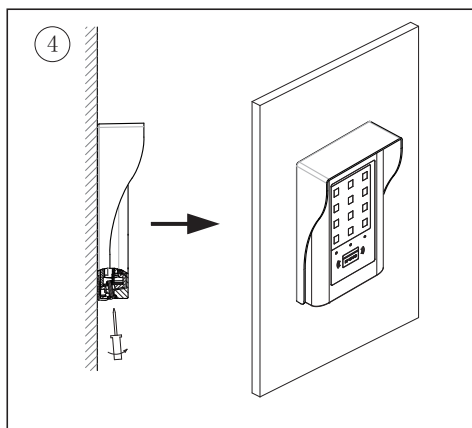
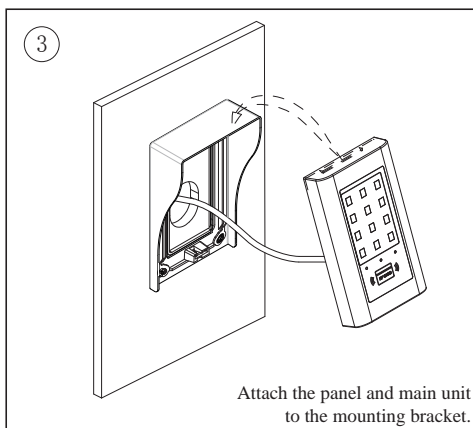
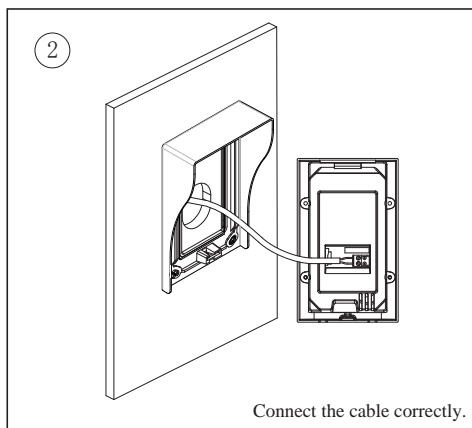
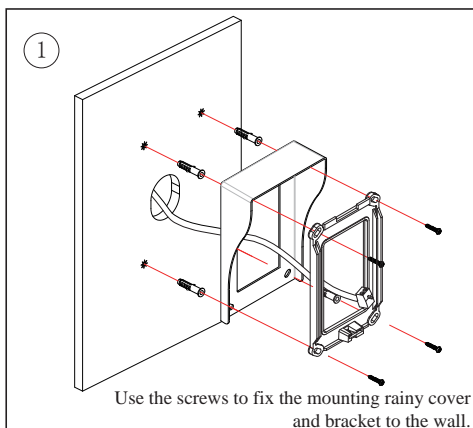

## 4. Electric Lock Connection

### 4.1 Internal Power Supply Mode

Use the power of the system to supply for the electronic lock, so that the lock can be connected to the access keypad panel directly, without an additional power supply for the electronic lock. Note that the access keypad panel can only output 12Vdc power, therefore the kind of lock is limited.

- The rated power of the lock must be less than 12Vdc 300mA when using internal power supply mode.
- The GND must connect to the negative of the lock, and the COM connect to the positive .
- The default unlock time is 3s. If different unlocking time is needed to be configured, change the Unlock Timing on access keypad panel.

A. Connection for Power-on-to-Unlock type:

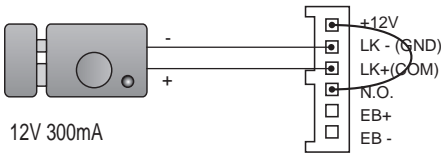

Set Unlock Relay mode to Normally Open(0)

B. Connection for Power-off-to-Unlock type:

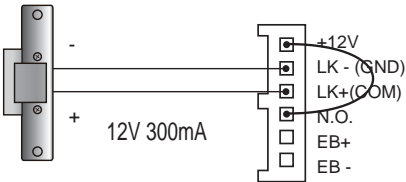

Set Unlock Relay mode to Normally Closed(1)

## 4.2 External Power Supply Mode

When the electronic lock is over 12 Vdc, external power supply for the lock is needed.

- The power supply for the lock must be less than 48Vdc 1.5A.
- The default unlock time is 3s. If different unlocking time is needed to be configured, change the Unlock Timing on access keypad panel.

C. Connection for Power-to-Unlock type:

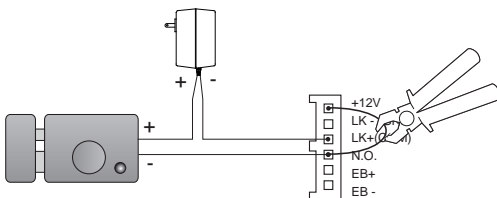

Set Unlock Relay mode to Normally Open(0)

Note: Cut off this line when using external power supply

#### D. Connection for Power--off-to-Unlock type:

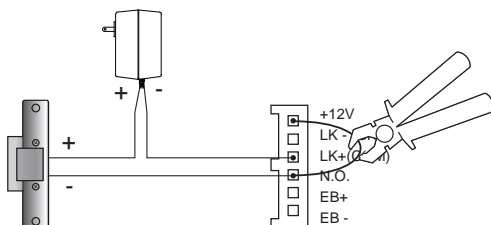

Set Unlock Relay mode to Normally Closed(1)

Note: Cut off this line when using external power supply

## 5. Functions Setup

This section explains the settings of each parameter, please refer to the following table:

About the setting mode:

Input the master code to enter the setting mode, and input the corresponding setting code to perform the settings for the function you want. After settings have been made, input the following setting codes to continue the setting operation. Press " \* " to exit the setting mode.



- The example is set \* as cancel button and # as confirm button, please refer to \*/# function setting for detail information.
- Forbid sliding touch to the digital keypad, it may cause mistaken key, the correct operation is using your finger to press the digital you desired.
- You should press "confirm" button after finish inputting the code number each time, otherwise, the operation will be canceled automatically after 10s.

### 5.1 Setting Items and Codes

Order	Setting items	Setting code	Setting range	Default value
1	Reset all settings	00	-	1,2,3,4
2	Set master code	01	1 ~ 12 digits Valid keys:0 ~ 9	1234
3	Set digitron display mode(in standby mode)	02	Valid keys:0 ~ 2	2

4	Set unlock time	03	1 to 99 seconds	1 seconds
5	Set unlock mode	04	0:opened/1:closed	opened
6	Set touch key prompt mode	05	0:No flashing and no beep / 1:flashing / 2: beep / 3:flashing + beep	1
7	Reset code settings	06	-	1,2,3,4
8	*&# function settings	07	0:Normal/1:Reverse	Normal
9	Tone select	08	0:Disable/1:Enable	1
10	Interference resistant grade settings	09	Valid keys:0 ~ 5	3
11	Keyboard mode	10	0:standard / 1:scramble	1
12	Unlock work mode	11	Valid keys:0~3	0
13	Backup(master / user card / password / tone)	12	-	1,2,3,4
14	Update(master / user card / password / tone)	13	-	1,2,3,4
15	Device Address	14	Valid keys:0~3	0
16	RLC Control	15	Valid keys:0~5	0
17	Temporary(single use only) password for relay1	18	Valid keys: 0 - 9	-
18	Temporary(single use only) password for relay2	19	Valid keys: 0 - 9	-
19	Set the code for user group 1	20-59	Valid keys: 0 - 9	-
20	Set the code for user group 2	60-99	Valid keys: 0 - 9	-
21	Register [Manage card]	100	-	1,2,3,4
22	Add user card	101	-	1,2,3,4
23	Delete user card	102	-	1,2,3,4
24	Format user card	103	-	1,2,3,4

## 5.2 LED Indicator Definitions

Indicator	Status	Description
LED1 ○	Light on	Release the first/second lock
LED2 ○	Light on	Register [Add Manage card] / Add user card
	Flash	Register [Delete Manage card] / Delete user card
	Double flash	Format or Configuration switching of DT-ACC and ID card, it waits for confirmation
LED3 ○	Light on	Setting code
	Flash	Setting value

## 5.3 Digitron Display Prompt

Digitron display	Prompt
OP1	Release the first lock
OP2	Release the second lock
SUC	Setting success
Err	Password error / Non-access card
Err 1	Setting code input error
Err 2	Setting value input error
Err 3	Cards have reached the number of rated
Err 4	Input rule error



Err 5	Wrong password 10 times in a row, is locked
Err 6	Swipe invalid user card(When unlocking need swipe valid user card and password )
ACC	The access control is configured for the DT-ACC application
ID	The access control is configured for the ID card unlock application
S-A	Register [Add Manage card]
S-D	Register [Delete Manage card]
ADD	Add user card
DEL	Delete user card
CLE	Format user card
BC1	Backup [Manage card]
BC2	Backup user card
BC3	Backup unlock password
BC4	Backup ringtones
UD1	Update [Manage card]
UD2	Update user card
UD3	Update unlock password
UD4	Update ringtones

## 5.4 Setting Steps

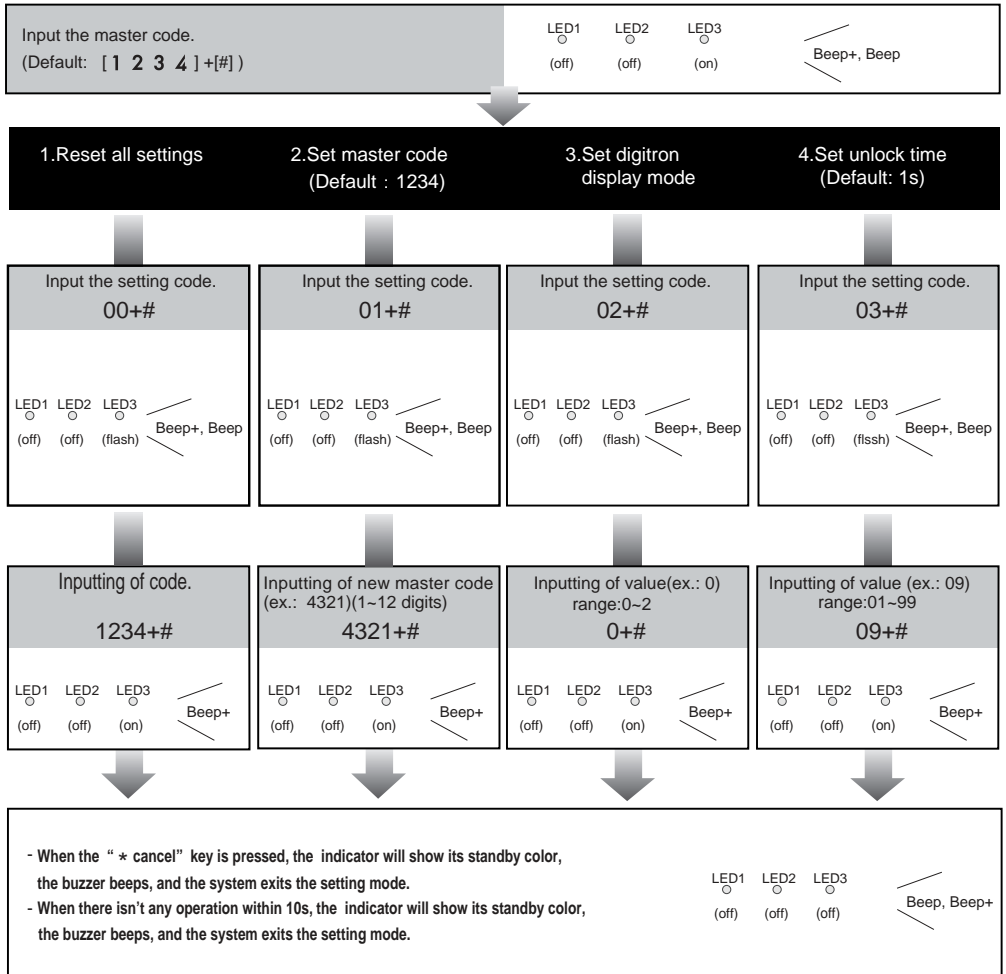

- All settings will restore to their default value.

- The master code is allowed 1~12 digits, the same code cannot be set for both the user code and the master code, it is recommended that you modify the default master code.

- Digitron display mode:  
0 : The scrolling display;  
1 : All digitron display “-” sign;  
2 : Only the upper left corner of the digitron display “-” sign.

- The unlock time can be set on access keypad panel, and the valid value is the number you set last time.

Input the master code.  
(Default: [ 1 2 3 4 ] +[#])

LED1 (off)    LED2 (off)    LED3 (on)    Beep+, Beep

5. Set unlock mode (Default : 0(opened))      6. Set touch key prompt mode      7. Reset code setting      8. \*[#] function setting (Default : Normal)

Input the setting code.  
04+#[#]

LED1 (off)    LED2 (off)    LED3 (flash)    Beep+, Beep

Input the setting code.  
05+#[#]

LED1 (off)    LED2 (off)    LED3 (flash)    Beep+, Beep

Input the setting code.  
06+#[#]

LED1 (off)    LED2 (off)    LED3 (flash)    Beep+, Beep

Input the setting code.  
07+#[#]

LED1 (off)    LED2 (off)    LED3 (flash)    Beep+, Beep

0/1  
Inputting of value (ex.: 1)  
range:0:(open)/1:(close)  
1+#[#]

LED1 (off)    LED2 (off)    LED3 (on)    Beep+

Inputting of value (ex.: 1)  
range:0~2  
1+#[#]

LED1 (off)    LED2 (off)    LED3 (on)    Beep+

Inputting of code  
1234+#[#]

LED1 (off)    LED2 (off)    LED3 (on)    Beep+

0/1  
Inputting of value (ex.: 1)  
range:0:(normal)/1:(reverse)  
1+#[#]

LED1 (off)    LED2 (off)    LED3 (on)    Beep+

- When the “ \* cancel” key is pressed, the indicator will show its standby color, the buzzer beeps, and the system exits the setting mode.  
- When there isn't any operation within 10s, the indicator will show its standby color, the buzzer beeps, and the system exits the setting mode.

LED1 (off)    LED2 (off)    LED3 (off)    Beep, Beep+

- The unlock mode can be set on access keypad panel, and the valid value is the number you set last time.

- When it is set to 0, there is no flash and no beep sound when pressing the touch key.  
- When it is set to 1, pressing the touch key will flash one time.  
- When it is set to 2, pressing the touch key will sent out a sound of beep.  
- When it is set to 3, pressing the touch key will flash one time and sent out a sound of beep.

- Cancel all the passwords except the master code.  
- Restore the master code to default value(1,2,3,4)

- When the item is set to 0, press the \* button to cancel the input, and press the # button to confirm the input.  
- When the item is set to 1, press the # button to cancel the input, and press the \* button to confirm the input .

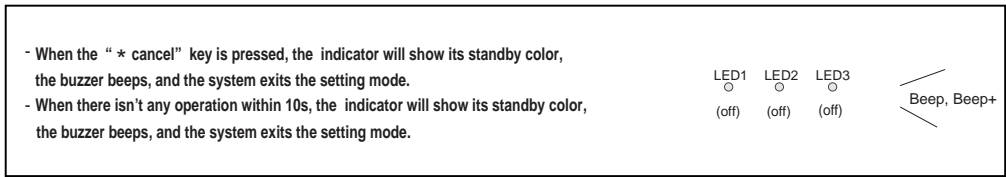
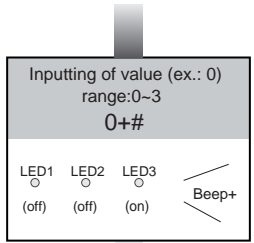
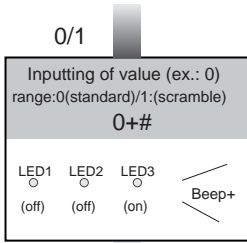
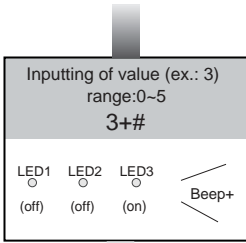
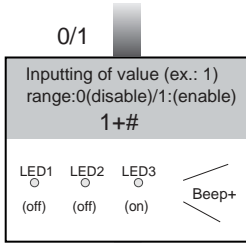
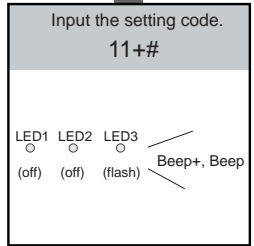
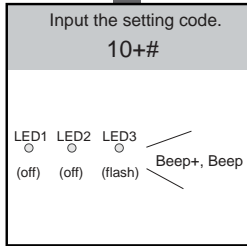
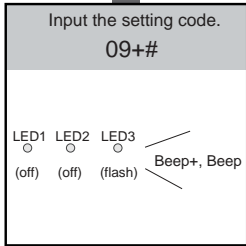
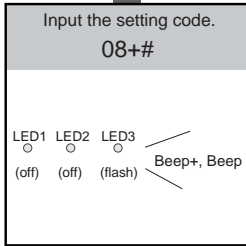

- If the item is set to 0, when unlock, the system will sent out a sound of Beep+.  
- If the item is set to 1, when unlock, the system will sent out a sound of “Door is open”.

- The larger you set the interference resistant grade, the stronger it will be, but the sensitivity of the keypad will be more lower.

- If the item is set to 0, the keyboard display mode is standard mode.  
- If the item is set to 1, the keyboard display mode is scramble mode.

- 0:Unlock via password or user card(only release the first lock).  
- 1:Unlock via password or user card(swipe user card once time to release the first lock; if swipe user card twice in a second to release the second lock).  
- 2:Unlock via user card and password(except the temporary password).  
- 3:Unlock via user card and password(including the temporary password).

Input the master code.  
(Default: [ 1 2 3 4 ] +[#])

LED1 (off)    LED2 (off)    LED3 (on)    Beep+, Beep

13. Backup(master / user card / password / tone)    14.Update(master / user card / password / tone)    15.Device address (Default:0)    16.RLC control (Default:0)

Input the setting code.  
12+#

LED1 (off)    LED2 (off)    LED3 (flash)    Beep+, Beep

Input the setting code.  
13+#

LED1 (off)    LED2 (off)    LED3 (flash)    Beep+, Beep

Input the setting code.  
14+#

LED1 (off)    LED2 (off)    LED3 (flash)    Beep+, Beep

Input the setting code.  
15+#

LED1 (off)    LED2 (off)    LED3 (flash)    Beep+, Beep

Inputting of code  
1234+#

LED1 (off)    LED2 (off)    LED3 (on)    Beep+

Inputting of code  
1234+#

LED1 (off)    LED2 (off)    LED3 (on)    Beep+

Inputting of value (ex.: 0)  
range:0-3  
0+#

LED1 (off)    LED2 (off)    LED3 (on)    Beep+

Inputting of value (ex.: 1)  
range:0-4  
1+#

LED1 (off)    LED2 (off)    LED3 (on)    Beep+

- When the “ \* cancel” key is pressed, the indicator will show its standby color, the buzzer beeps, and the system exits the setting mode.  
- When there isn't any operation within 10s, the indicator will show its standby color, the buzzer beeps, and the system exits the setting mode.

LED1 (off)    LED2 (off)    LED3 (off)    Beep, Beep+

- When backup, you need to insert SD card into the SD card slot.

- When update, you need to insert SD card(the update file is stored in SD card) into the SD card slot.

- Device address Settings:  
0(device address:0),1(device address:1),2(device address:2), 3(device address:3).

- DT-RLC association control:  
0:According to AKP address auto-correlation;  
1:Association of the first RLC;  
2:Association of the second RLC;  
3:Association of the third RLC;  
4:Association of the fourth RLC.  
5:Not associated with RLC.

Input the master code.  
(Default: [ 1 2 3 4 ]+[#] )

LED1 (off) LED2 (off) LED3 (on) Beep+, Beep

17. Temporary (single use only) password for relay 1      18. Temporary (single use only) password for relay 2      19. Set the code for user group 1      20. Set the code for user group 2

<p>Input the setting code. <b>18+#</b></p> <p>LED1 (off) LED2 (off) LED3 (flash) Beep+, Beep</p>	<p>Input the setting code. <b>19+#</b></p> <p>LED1 (off) LED2 (off) LED3 (flash) Beep+, Beep</p>	<p>20~59 Input the setting code. (ex.:21) <b>21+#</b></p> <p>LED1 (off) LED2 (off) LED3 (flash) Beep+, Beep</p>	<p>60~99 Input the setting code. (ex.:60) <b>60+#</b></p> <p>LED1 (off) LED2 (off) LED3 (flash) Beep+, Beep</p>
--	--	---	---

<p>Inputting of value (ex.: 1006) 1~12 digits <b>1006+#</b></p> <p>LED1 (off) LED2 (off) LED3 (on) Beep+</p>	<p>Inputting of code (ex.: 2016) 1~12 digits <b>2016+#</b></p> <p>LED1 (off) LED2 (off) LED3 (on) Beep+</p>	<p>Inputting of code (ex.: 2011) 1~12 digits <b>2011+#</b></p> <p>LED1 (off) LED2 (off) LED3 (on) Beep+</p>	<p>Inputting of code (ex.: 2012) 1~12 digits <b>2012+#</b></p> <p>LED1 (off) LED2 (off) LED3 (on) Beep+</p>
--	---	---	---

- When the “ \* cancel” key is pressed, the indicator will show its standby color, the buzzer beeps, and the system exits the setting mode.

- When there isn't any operation within 10s, the indicator will show its standby color, the buzzer beeps, and the system exits the setting mode.

LED1 (off) LED2 (off) LED3 (off) Beep, Beep+

- Once input the correct temporary password to release the door, the system will clear the temporary password after 60 seconds automatically. But the password is still valid within 60 seconds after inputting the correct temporary password.
- The temporary 1 is used to release the first lock, and the temporary 2 is used to release the second lock (the second lock need external device to support).
- If the password exceeds 12 digits, the system will make the sound of “beep,beep,beep,beep”, and the digitals you input before will be cleared at the same time.
- The temporary code can not be set the same as the master code and user code.
- The user code group 1 is used to release the first lock, and the user code group 2 is used to release the second lock (the second lock need external device to support).
- The user code group 1 and user code code group 2 can contain 40 group passwords
- If the password exceeds 12 digits, the system will make the sound of “beep,beep,beep,beep”, and the digitals you input before will be cleared at the same time.
- The user code can not be set the same as the master code and temporary code.

Input the master code.  
(Default: [ 1 2 3 4 ]+[#])

LED1 (off) LED2 (off) LED3 (on) Beep+, Beep

21.Register [Manage card]      22.Add user card      23.Delete user card      24.Format user card

Input the setting code.  
100+#

LED1 (off) LED2 (off) LED3 (flash) Beep+, Beep

Input the setting code.  
101+#

LED1 (off) LED2 (off) LED3 (flash) Beep+, Beep

Input the setting code.  
102+#

LED1 (off) LED2 (off) LED3 (flash) Beep+, Beep

Input the setting code.  
103+#

LED1 (off) LED2 (off) LED3 (flash) Beep+, Beep

Inputting of code  
1234+#

LED1 (off) LED2 (on) LED3 (off) Beep+

Inputting of code  
1234+#

LED1 (off) LED2 (on) LED3 (off) Beep+

Inputting of code  
1234+#

LED1 (off) LED2 (flash) LED3 (off) Beep+

Inputting of code  
1234+#

LED1 (off) LED2 (off) LED3 (off) Beep+

Swipe MASTER CARD ADD card and MASTER CARD DELETE card in the ID window.

LED1 (off) LED2 (flash) LED3 (off) Beep+

Swipe new user card one by one to be added in the ID window.

LED1 (off) LED2 (on) LED3 (off) Beep+

Swipe user card one by one to be deleted in the ID window.

LED1 (off) LED2 (flash) LED3 (off) Beep+

- When the “ \* cancel” key is pressed, the indicator will show its standby color, the buzzer beeps, and the system exits the setting mode.  
- When there isn't any operation within 10s, the indicator will show its standby color, the buzzer beeps, and the system exits the setting mode.

LED1 (off) LED2 (off) LED3 (off) Beep, Beep+

- Swipe the first card to ID card window, it will be set to MASTER CARD ADD card.  
- Swipe the second card to ID card window, it will be set to MASTER CARD DELETE card.  
-When registered new master cards, the old master cards are invalid automatically.

- Another way:  
Swipe the MASTER CARD ADD card to ID card window in standby mode, and then swipe user cards one by one to be added.

- Another way:  
Swipe the MASTER CARD DELETE card to ID card window in standby mode, and then swipe user cards one by one to be deleted.





## 7.Unlock Operations

### Unlock by user code

When the registered user code has been input using the keypad (1~12 digits), the digitron will display "OP1" or "OP2", and the LED1 indicator lights up, and the system will synthesis sound of "Door is open"(If the **Tone Select** item is set to 1), then the electric door strike is unlocked.(note that you should press "#" button(if "#" button is set to confirm button) after input the unlock code)

- The time interval between 2 digitals' input must be less than approximately 10 seconds. otherwise the input value will be cleared.
- If you make a mistake when inputting the user code,press the" cancel" button and input the user code again.
- The release function is forbidden and the input operation is disabled for 60 seconds if 10 times incorrect access codes are continuously attempted. During this time,the buzzer will continuously sound about 8 times.

### Unlock by user card

When the registered user card has been shown to ID card window, the digitron will display "OP1"(if swipe user card twice in a second in the ID card window, the digitron will display "OP2"), and the LED1 indicator lights up, and the system will synthesis sound of "Door is open"(If the **Tone Select** item is set to 1), then the electric door strike is unlocked.

## 8.Specifications

- |                             |  |
|-----------------------------|--|
| • Power Supply :            | DC 24V;  |
| • Power Consumption:        | Standby 23mA; Working status 43mA;                 |
| • Unlocking time:           | 1~99s  |
| • Lock Power supply:        | 12Vdc, 280mA(Internal Power);                      |
| • Number of relay circuits: | 2(the second lock need external device to support) |
| • Mounting:                 | Surface mounting                                   |
| • Working temperature:      | -15°C ~ +55°C                                      |
| • Dimension:                | 151(H)×95(W)×37(D)mm                               |

## 9.Precautions

- Please clean the unit with soft cotton cloth, don't use the organic impregnant or chemical clean agent. If necessary, please use a little pure water or dilute soap water to clean the dust.
- The unit is weather resistant. However do not spray high pressure water on access control keypad directly. Excessive moisture may cause problems with the unit.
- You must use the right adaptor which is supplied by the manufacture or approved by the manufacture.
- Pay attention to the high voltage inside the products, please refer service only to a trained and qualified professional.
- The design and specifications can be modified without notice to the user. Right to interpret and copyright of this manual are reserved.





The design and specifications can be modified without notice to the user. Right to interpret and copyright of this manual are reserved.