

DT-RLC

Relay actuator

User Manual

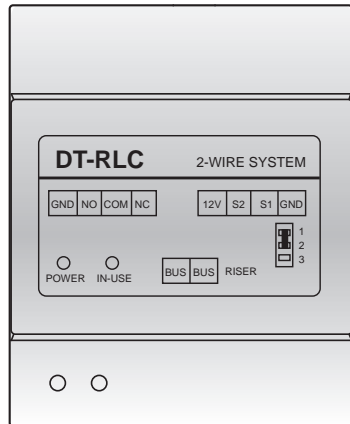

Please read this manual carefully before using the product you purchase, and keep it well for future use. We reserve the right to modify the specification in this manual at any time without notice.

1.About DT-RLC Unit

Description:

The relay actuator DT-RLC is a accessory device designed for DT system to control door locks or lights. It has the features as follows:

- It has two work modes: lock control mode and light control mode;
- Allows to open gate door locks or control lights;
- Support high power-consumption lock;
- With configurable unlock timed output or light control timed output;
- Support exit control button: when in lock control mode, the exit control button to control the lock; when in light control mode, the exit control button to control the light.

2. Parts and Name

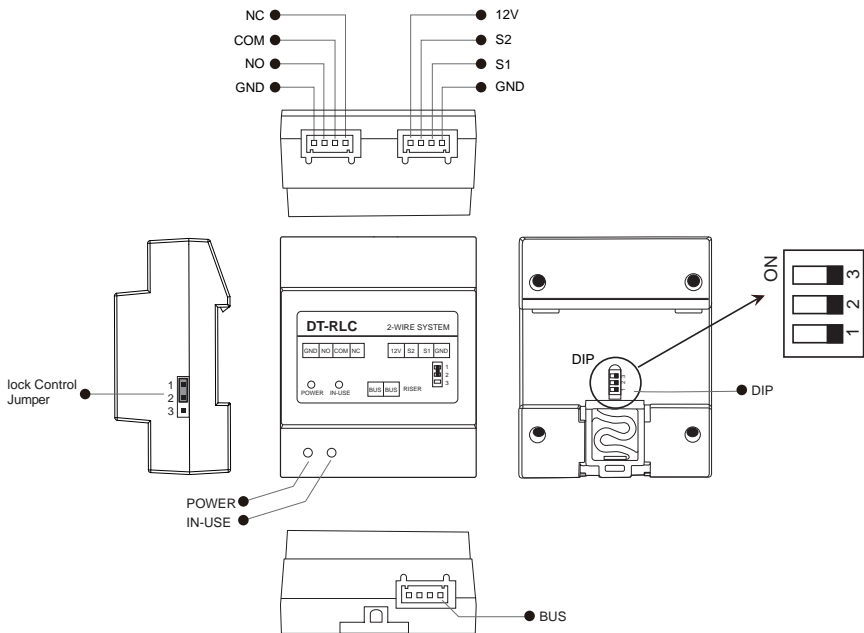

+12V:12V power output. Can be used to power the lock.

S2:Reserved.

S1:Exit button contact. Short this contact and the GND to unlock or control light.

GND:The common Ground of the other 3 contacts: S1, S2 and +12V.

NC: The normally-closed contact to COM.

COM: The common contact of the unlock/light relay.

NO: The normally-open contact to COM.

Lock Control Jumper: To select the lock type: see section 5.3, 5.4.

POWER: Working indicator, it will light up when plugs in power supply.

IN-USE: Unlock/light indicator, it will light up when unlock (or turn on the light).

Bus: Connect to the bus line, no polarity.

DIP : Used for setting the address of the RLC.

3. Unit Mounting

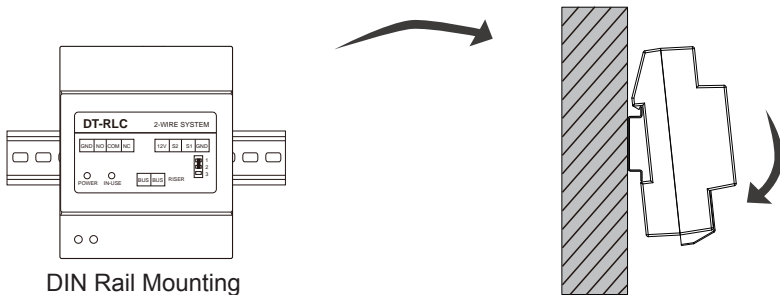

4. How To Set The Work Mode

Note that the factory default is lock control mode.

1). In DIP1 = ON, DIP2 = ON, DIP3 = OFF status, exit button (S1 and GND) short-circuit, meanwhile, the DT-RLC will power-on to activate the setting mode;

2). In setting status, struck repeatedly DIP1 four times to switch work modes:

A. When the IN-USE indicator flashes once, it means the system will enter the lock control mode.

B. When the IN-USE indicator flashes two times, it means the system will enter the light control mode.

3). When the setting complete, it will automatically restart.

Please note the setting state valid within 5 seconds, more than five seconds without operation, it will exit the setting mode automatically.

5. Lock Control Mode

In lock control mode, the DT-RLC allows to open gate door locks; Support high power-consumption lock; With configurable unlock timed output; Support exit control button.





5.1 How to set the unlock time



In lock control mode:

- 1). Power-on within 5 seconds, short-circuit S2 up to 3 seconds, the IN-USE indicator flash.
- 2). Short-circuit S1 up to 3 seconds, and the IN-USE indicator always light.
- 3). Short-circuit again S2, meanwhile, the time of short-circuit equal to unlock time. (the IN-USE indicator flashes once per second, Less than two seconds by one second calculation; The maximum setting time is 30 seconds.)
- 4). After S2 released, saved unlock time, and exit the setting.

5.2 DIP setting for lock

The DIP switch in the back of the panel is used to set the address of the RLC. Please refer to the followings for more detail informations about the DIP settings:

DIP	Bit State	Descriptions
	OFF,OFF,OFF	Applies to door station1 & lock 1
	OFF,OFF,ON	Applies to door station1 & lock 2
	ON,OFF,OFF	Applies to door station2 & lock 1
	ON,OFF,ON	Applies to door station2 & lock 2
	OFF,ON,OFF	Applies to door station3 & lock 1

DIP	Bit State	Descriptions
	OFF,ON,ON	Applies to door station3 & lock 2
	ON,ON,OFF	Applies to door station4 & lock 1
	ON,ON,ON	Applies to door station4 & lock 2

5.3 Internal powered lock connection(only suitable for Power-on-to-unlock type)

DT-RLC control the second lock of door station 1

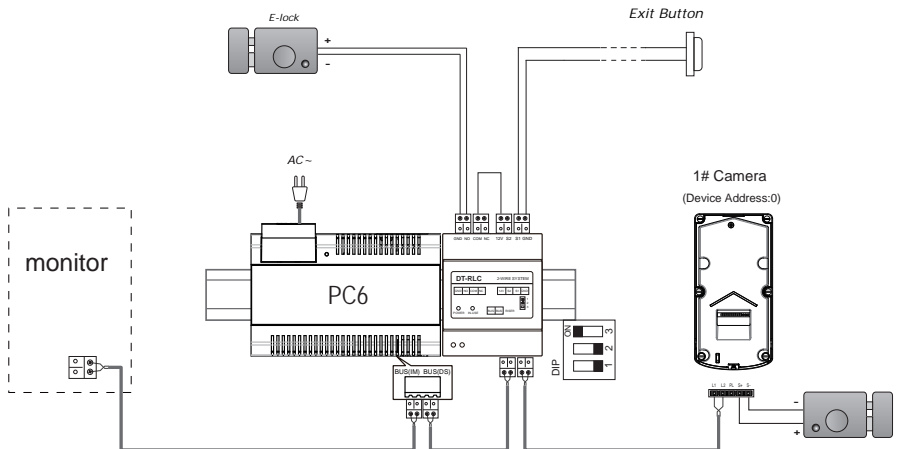

DT-RLC connect lock

Note:

1. When DT-RLC connect Electronic lock, the jumper position in 1-2.
2. When DT-RLC connect E-magnetic lock, the jumper position in 2-3.

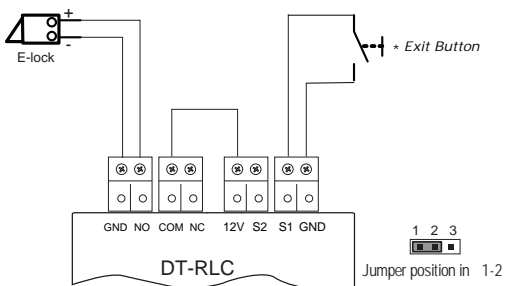

5.4 External Power Supply powered lock connection

A. Power-on-to-unlock type:

DT-RLC control the second lock of door station 1

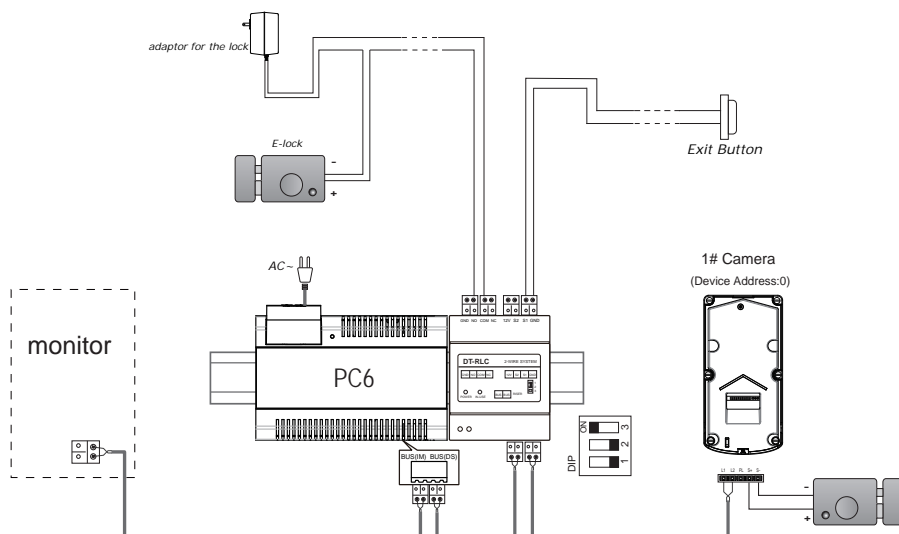

DT-RLC connect lock

Note:

1. Here's lock type is Electronic lock.

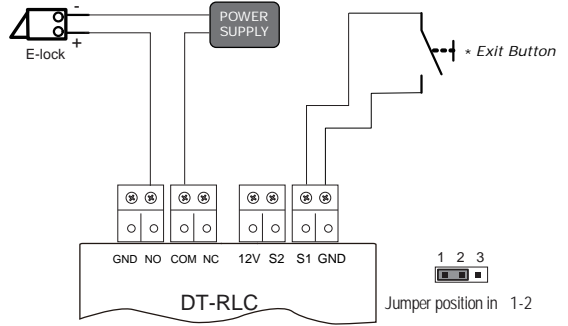

B. Power-off-to-unlock type:

DT-RLC control the second lock of door station 1

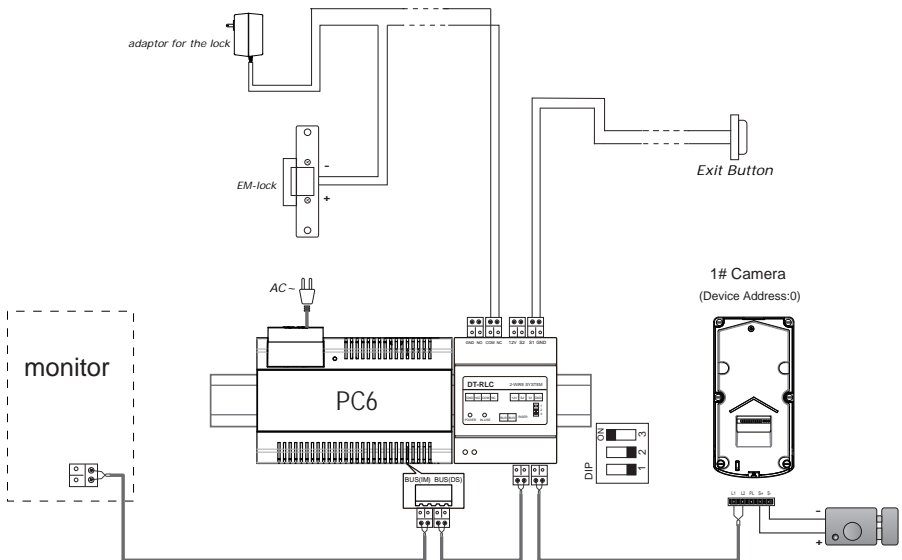

DT-RLC connect lock

Note:

- Here's lock type is E-magnetic lock.

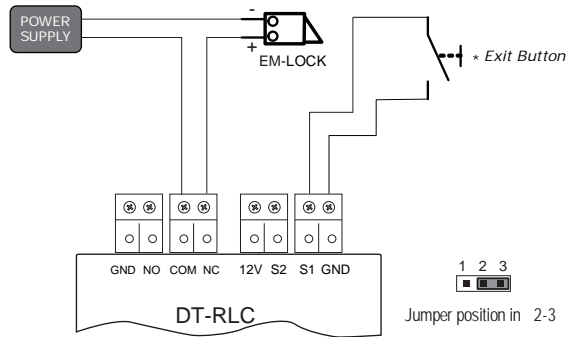

6. Light Control Mode

In light control mode, the DT-RLC allows to control lights; With configurable light timed output; Support exit control button.







6.1 How to set the light working time

In light control mode:

- Power-on within 5 seconds, short-circuit S2 up to 3 seconds, the IN-USE indicator flash.
- Short-circuit S1 up to 3 seconds, and the IN-USE indicator always light.
- Short-circuit again S2, meanwhile, the time of short-circuit 1 seconds equal to light working time 30 seconds.(the IN-USE indicator flashes once per second; The maximum setting time is 900 seconds.)
- After S2 released, saved unlock time, and exit the setting.

6.2 DIP setting for light

DIP	Bit State	Descriptions
	OFF,OFF,OFF	Set to the first DT-RLC.

DIP	Bit State	Descriptions
	OFF,OFF,ON	Set to the second DT-RLC.
	ON,OFF,OFF	Set to the third DT-RLC.
	ON,OFF,ON	Set to the fourth DT-RLC.
	OFF,ON,OFF	Set to the fifth DT-RLC.
	OFF,ON,ON	Set to the sixth DT-RLC.
	ON,ON,OFF	Set to the seventh DT-RLC.
	ON,ON,ON	Set to the eighth DT-RLC.

6.3 DT-RLC Connections for Light Control

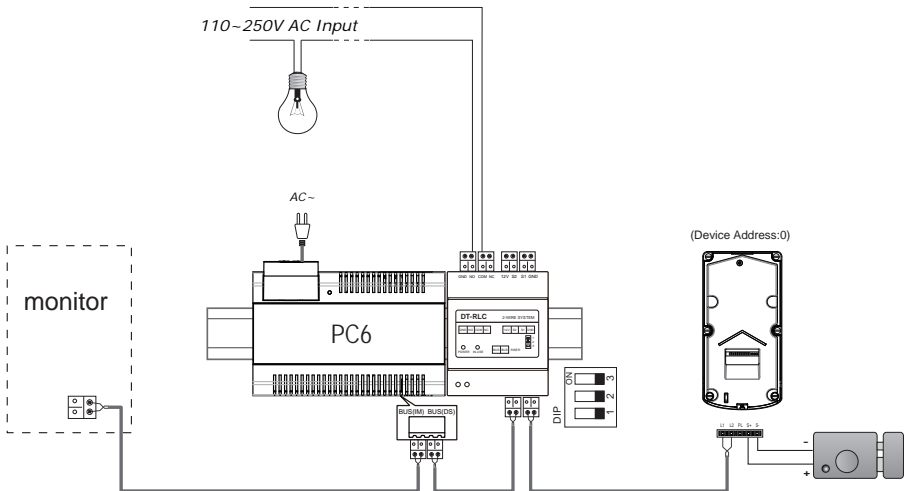

7. Connecting 2 DT-RLCs

In one system, you can connect a DT-RLC to control gate door lock, and connect another DT-RLC to control light.

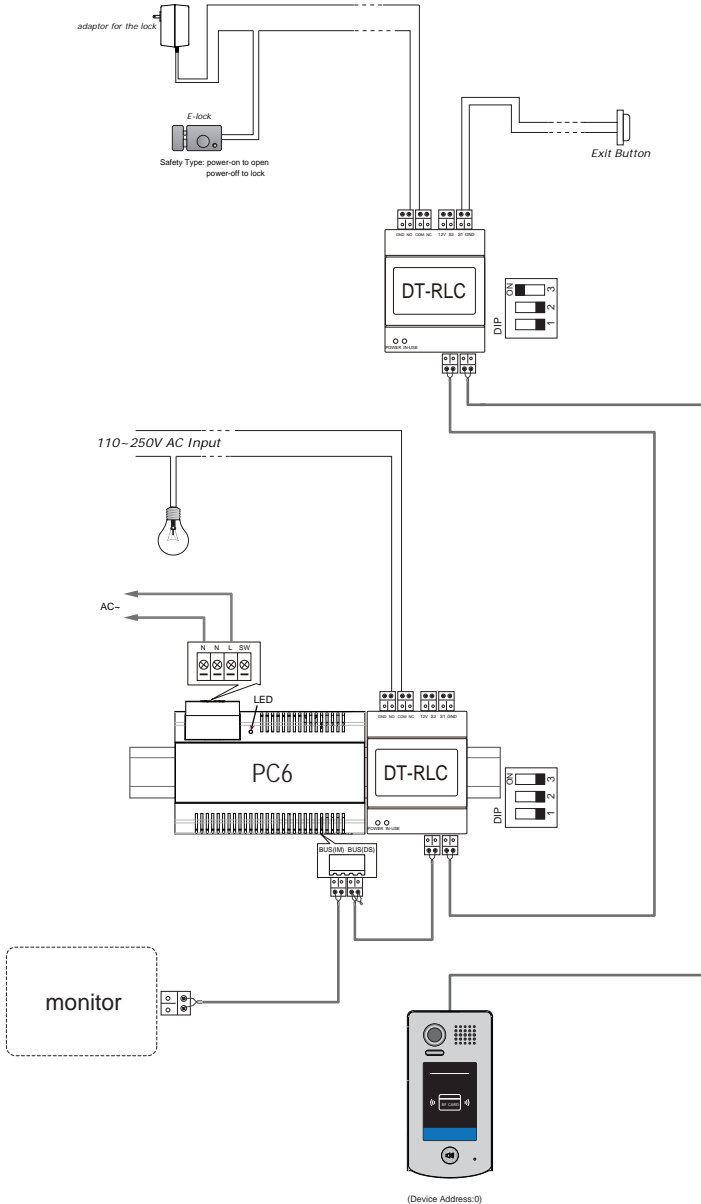

8. Specification

- Power Supply : DC24V;
- Unlocking Time: 1~30s(Default 1s);
- Lock Power supply: 12Vdc, 450mA(Internal Power);
- Working Temperature: -10°C~+40°C;
- Dimension: 89(H)×71(W)×45(D)mm.

The design and specifications can be changed without notice to the user. Right to interpret and copyright of this manual are preserved.